

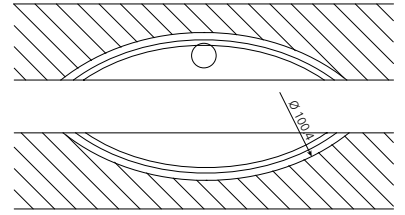

Clamex P-10

Pat. pend.

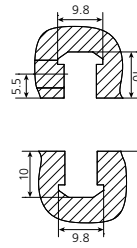
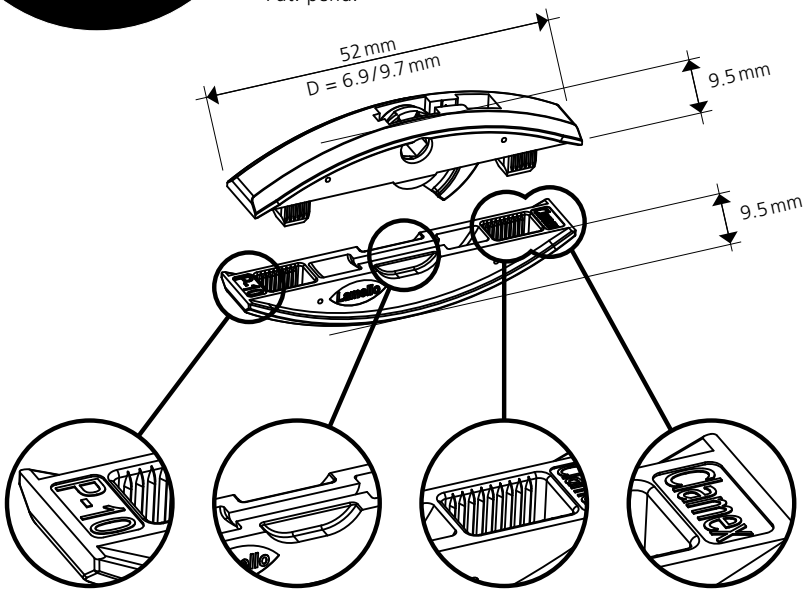

Zugbruchfestigkeit / Tensile strength:

- Spanplatte / particle board:
~ 600 N = 60 kg
- Buche massiv / beech massive:
~ 900 N = 90 kg
- MDF:
~ 600 N = 60 kg

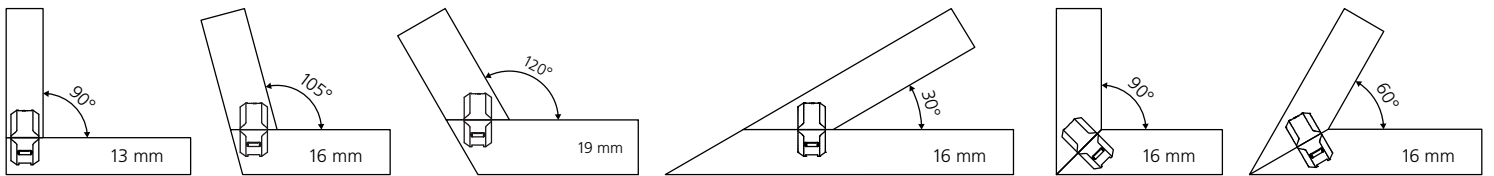
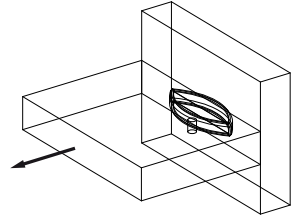

P-10

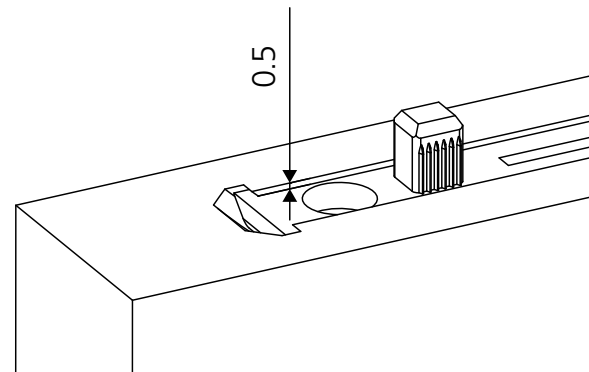
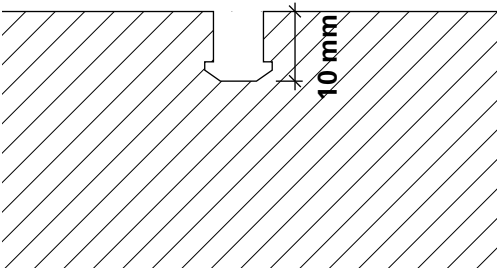

Scharfe Fräser verwenden
Use sharp cutters

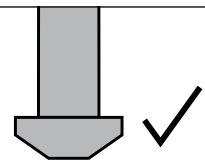
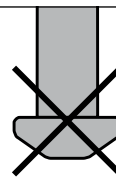

Tenso P-14



Paar / Pair / Paire / Paio	Art. No.
80	145410
300	145420
1000	145431

Clamex P Medium 14/10



Paar / Pair / Paire / Paio	Art. No.
80	145370
300	145371

Clamex P-14



Paar / Pair / Paire / Paio	Art. No.
80	145334
300	145346
1000	145356

Bisco P-15/14



Stück / piece / pièce / pezzi	Art. No.
80	145301
300	145302
1000	145303

Clamex P-10



Paar / Pair / Paire / Paio	Art. No.
80	145372
300	145373
1000	145374

Bisco P-10



Stück / piece / pièce / pezzi	Art. No.
80	145304
300	145305

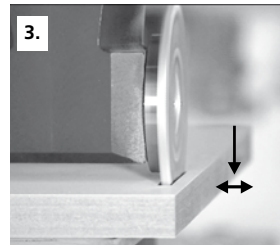
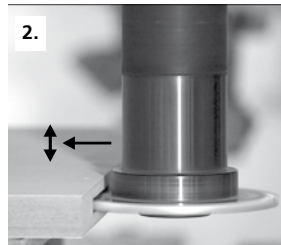
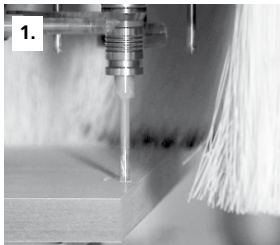
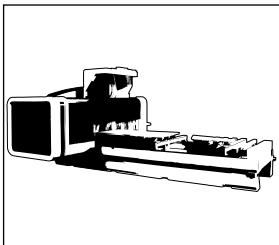
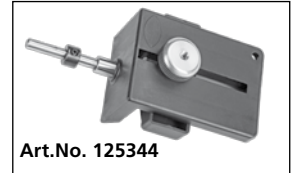
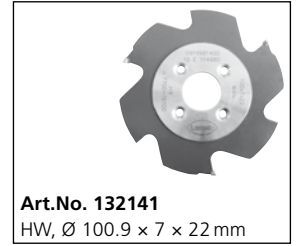
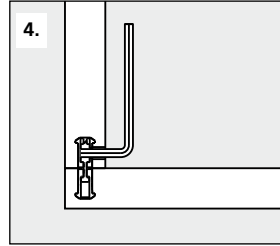
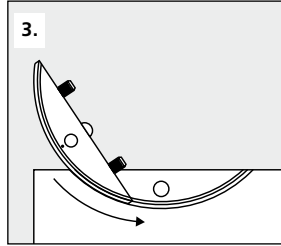
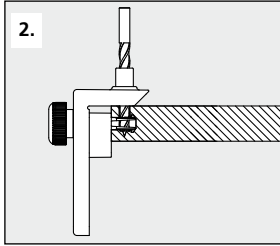
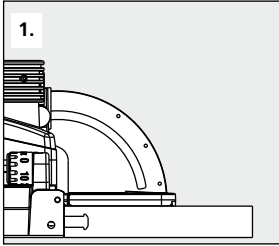
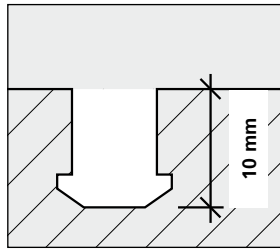
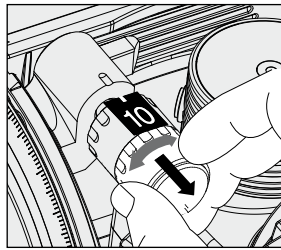
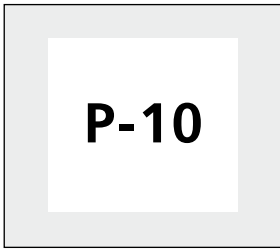
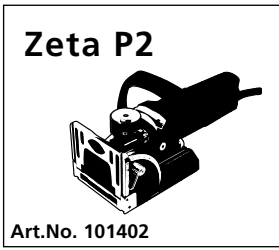

Art. No. 132142
DP, 100.4 × 7 × 30 mm
4 / 6.6 / DTK 48 mm
* Passend zu allen aufgeführten Fräsdornen
Suitable for all cutter arbors listed

Art. No. 132143
DP, 100.4 × 7 × 40 mm
4 / 5.5 / DTK 52 mm

Art. No. 132144
DP, 100.4 × 7 × 16 mm
4 / 5.5 / DTK 28 mm

* **Art. No. 132150**
20 × 50, L = 102 mm

* **Art. No. 132151**
25 × 60, L = 102 mm

* **Art. No. 132152**
16 × 50, L = 85 mm

* **Art. No. 132153**
16 × 55, L = 68 mm

* **Art. No. 132154**
16 × 50, L = 85 mm, mit Spannfläche (2°-schräg) / with clamping surface (2°- angle)

* **Art. No. 132155**
20 × 50, L = 85 mm, mit Spannfläche (2°-schräg) / with clamping surface (2°- angle)

Abdeckkappen / Cover caps
100 Stück / 100 pieces

90°

RAL	Art. No.
9010	335280
9011	335281
1014	335282
1011	335283
8007	335284
9002	335285
7035	335286
7040	335287
7031	335288

45°

RAL	Art. No.
9010	335380
9011	335381
1014	335382
1011	335383
8017	335384
7022	335388

