







**Fitting for pivoting and lateral sliding in of wooden doors up to 50 kg (110 lbs.). Enables multi-functional room design, paired with a flush-fitting design.**

**Product highlights**

-  **Flexibility** Tremendous flexible door dimensions provides a high degree of design freedom
-  **Comfort** Easy, quiet operation thanks to soft closing mechanism and hinges with integrated soft closing mechanism

**Technical specifications**

-  Max. 25—50 kg (55 to 110 lbs.)
-  Max. 2301—2850 mm (7'6 19/32" to 9'4 7/32")
-  Max. 300—900 mm (11 13/16" to 2'11 7/16")
-  19—30 mm (3/4" to 1 31/32")







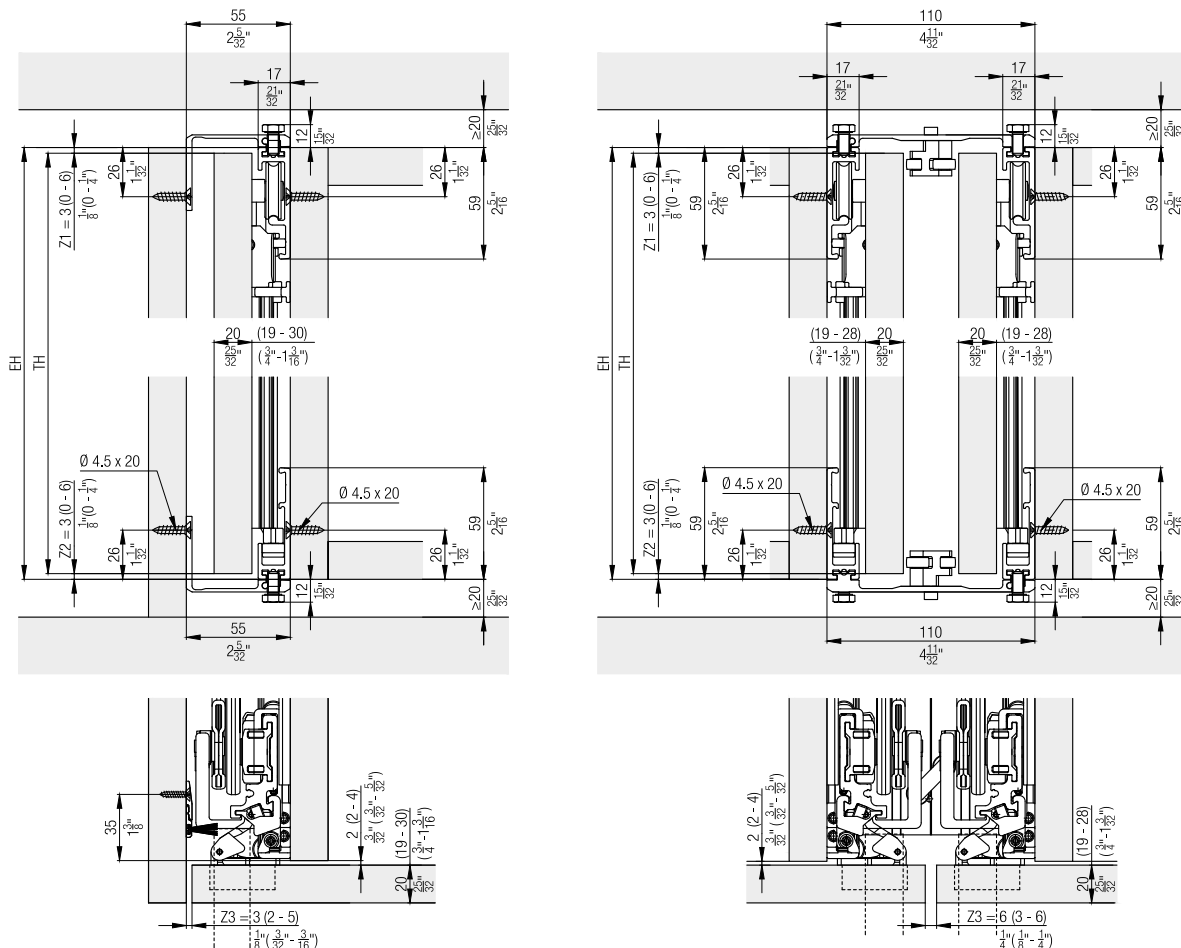



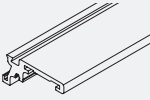

**Installation examples**

**Door striking against the top and bottom cabinet sections**



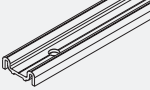



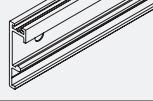
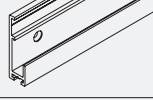
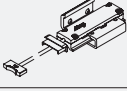

**Set for 1 pivot /slide-in door up to 50 kg (110 lbs.)**

Hawa Concepta 50, for 1 door		No.			
		27651			
<b>Set consisting of:</b>		27651	No.		
	Upright, 2760 mm (9' 21/32"), aluminium, anodized			1	22057
	Running gear, ball bearing, with torsion plate, height adjustable, aluminum, nickel matt			1	24955
	Upright guide, rattle proof, with plastic rollers			1	25656
	Scissor action complete, 1500 mm (4'11 1/16"), steel, galvanized			1	22594
	Front scissor guide, aluminum, anodized			1	25592
	Rear scissor guide, aluminum, anodized			1	25596
	Rear scissor bearing, 55 mm (2 5/32"), steel, galvanized			1	25855
	Concealed hinge, with damper, steel, galvanized, 5 piece-set			1	27656
	Set of screws for concealed hinges, 4x16 mm (5/8"), set of 10 pieces			1	25935
	Spacer profile, 860 mm (2'9 27/32"), pre-drilled, plastic, black			1	22861
	Set of screws for spacer profile, PH 4x16 mm (5/8"), set of 7 pieces			1	25562
	Brush guide, plastic, black, set of 3 pieces			1	25815

Continued table on next column

Table continued from previous column

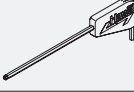
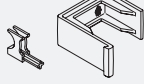
	Running track, 896 mm (2'11 9/32"), aluminium, anodized, pre-drilled	1	24528
	Bottom guide channel, 896 mm (2'11 9/32"), aluminium, anodized, pre-drilled	1	24535
	Stop damper, with retaining bracket	1	24660
	Door retractor 25/50, with damper, plastic, black	1	25814
	Stop cover cap Hawa Concepta, depth adjustable, top left/bottom right	1	27657
	Stop cover cap Hawa Concepta, depth adjustable, top right/bottom left	1	27658
	Cover plates, stainless steel, 1 pair	1	24739
	Soft closing system for end position, with cover caps, plastic, black	1	25862
	Screw set, 4,5x20 mm (25/32"), set of 22 pieces	1	22451
	Allen key, with handle, 3 mm (1/8")	1	13164
	Installation aid, plastic, red	1	25816

**Cabinet connecting profile**

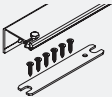
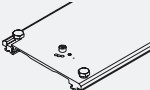
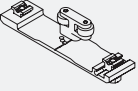
		mm (inch)	No.
	Connector 55 mm (2 5/32"), for one pivot/slide-in door, aluminum, plain anodized, 2 pieces	650 (2' 1 19/32")	25438
	Connector 55 mm (2 5/32"), for one pivot/slide-in door, aluminium, anodized, 1 piece	650 (2' 1 19/32")	23221
		900 (2' 11 7/16")	23222
	Connector 110 mm (4 11/32"), for two pivot/slide-in doors, aluminium, anodized, 1 piece	650 (2' 1 19/32")	23223
		900 (2' 11 7/16")	23224
	Connector 110 mm (4 11/32"), for two pivot/slide-in doors, aluminium, anodized, 1 piece (for installation in front of a fixed base)	26 (1 1/32")	23225

**Guides**

		No.
	Guide for two inset pivot sliding doors, aluminum	25680

**Door handles**

		mm (inch)	No.
	Door handle, aluminum, anodized	400 (1' 3 3/4")	22692

**Door handle height**

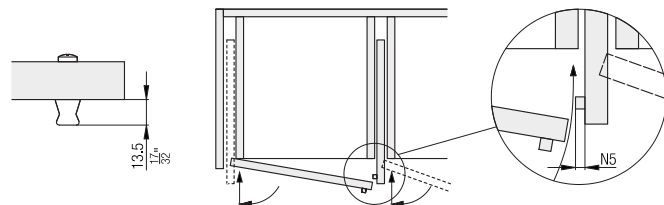

Further installation examples  
Inset door

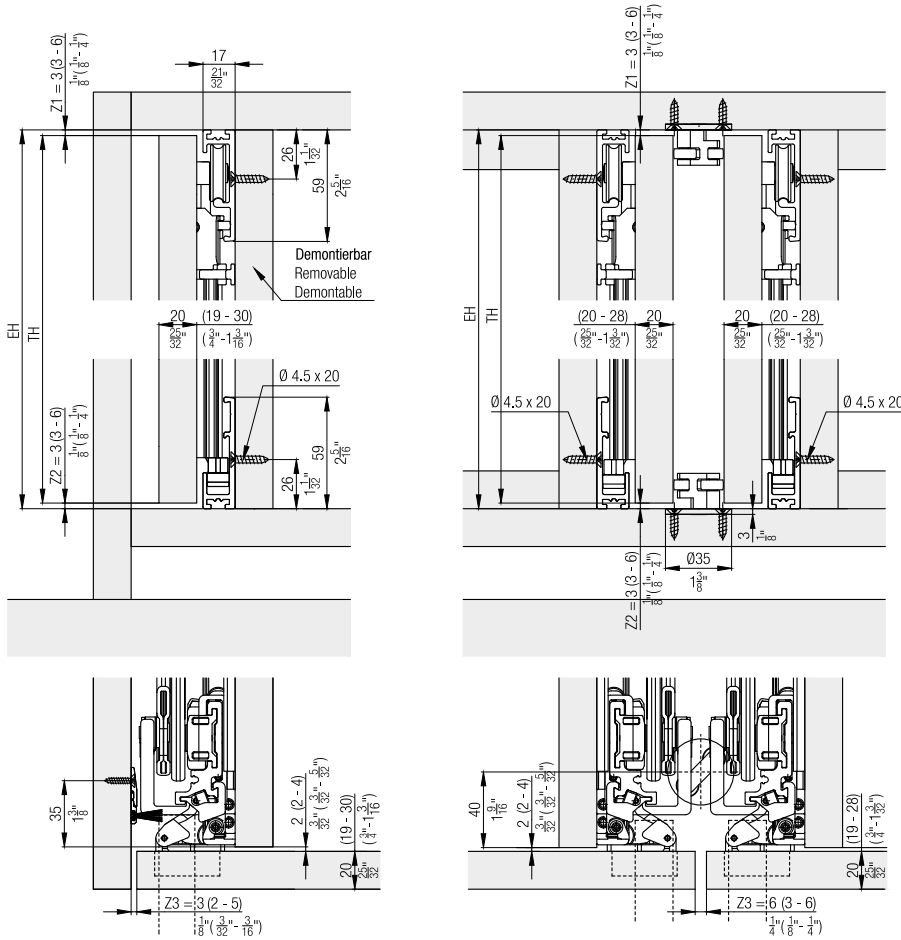

Door in wall niche

Door thickness 31–50 mm (1 7/32" to 1 31/32")

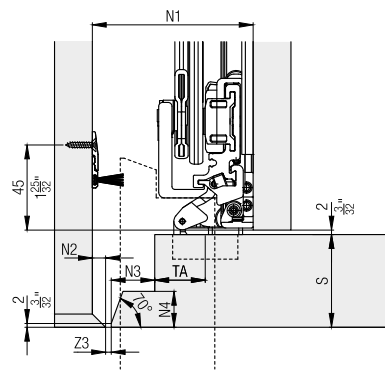
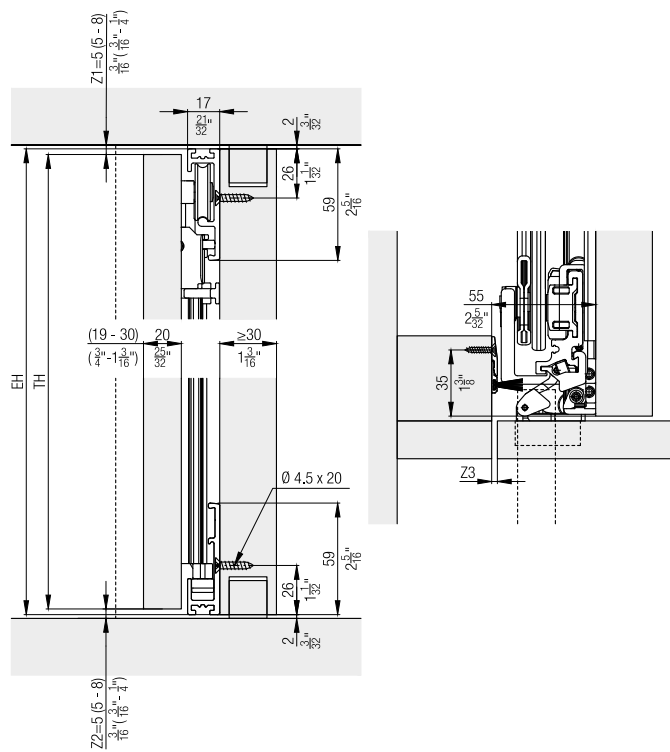

S	N1	N2	N3	N4
19-30 mm	55 mm	0 mm	0 mm	0 mm
33 mm	58 mm	0 mm	3 mm	3 mm
36 mm	63 mm	2 mm	6 mm	5 mm
39 mm	67 mm	3 mm	9 mm	8 mm
42 mm	70 mm	3 mm	12 mm	11 mm
45 mm	75 mm	5 mm	15 mm	14 mm
48 mm	79 mm	6 mm	18 mm	17 mm
50 mm	83 mm	7 mm	21 mm	19 mm

S	N1	N2	N3	N4
3/4" - 1 3/16"	2 3/16"	0	0	0
1 5/16"	2 9/32"	0	1/8"	1/8"
1 7/16"	2 1/32"	3/32"	1/4"	7/32"
1 17/32"	2 21/32"	1/8"	3/8"	5/16"
1 21/32"	2 3/4"	1/8"	15/32"	7/16"
1 25/32"	2 31/32"	7/32"	19/32"	9/16"
1 29/32"	2 5/8"	1/4"	23/32"	11/16"
1 31/32"	2 9/32"	9/32"	27/32"	3/4"

**Fitting depth calculations**

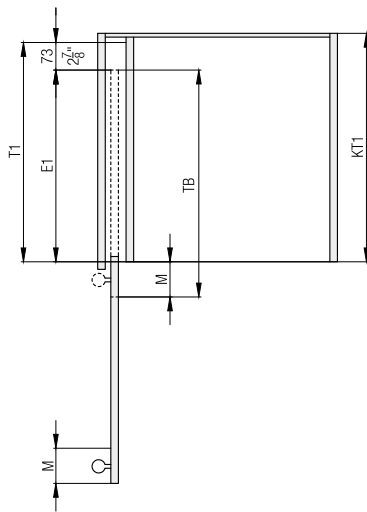

$$T1 = TB - M + 73 \text{ mm}$$

$$E1 = T1 - 73 \text{ mm}$$

$$T1 = TB - M + 2\frac{7}{8}''$$

$$E1 = T1 - 2\frac{7}{8}''$$

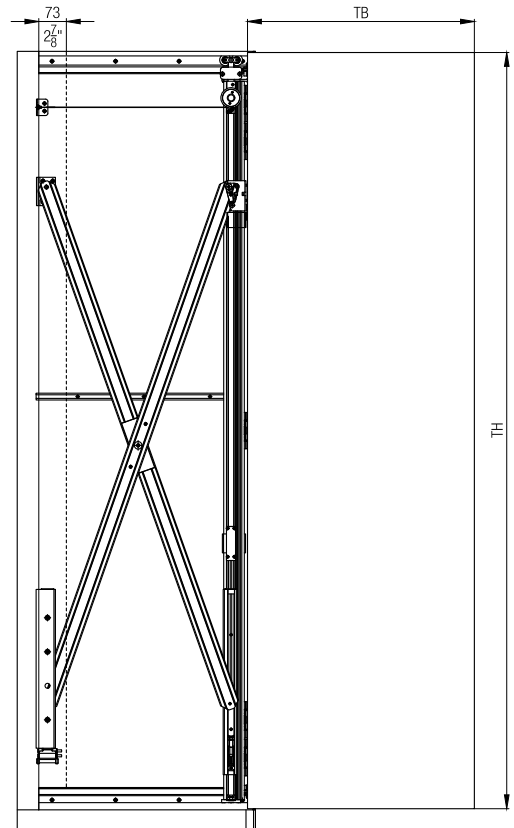

	T1	TH	E1
Hawa Concepta 40	≤ 900 mm	1851 - 2500 mm	300 - 827 mm

	T1	TH	E1
Hawa Concepta 40	≤ 2' 11 $\frac{7}{16}$ "	6' 0 $\frac{7}{8}$ " - 8' 2 $\frac{7}{16}$ "	11 $\frac{13}{16}$ " - 2' 8 $\frac{9}{16}$ "

	T1	TH	E1
Hawa Concepta 50	≤ 900 mm	2301 - 2850 mm	300 - 827 mm

	T1	TH	E1
Hawa Concepta 50	≤ 2' 11 $\frac{7}{16}$ "	7' 6 $\frac{19}{32}$ " - 9' 4 $\frac{7}{32}$ "	11 $\frac{13}{16}$ " - 2' 8 $\frac{9}{16}$ "

**Weight and door size ratio calculations**

The maximum weight must be adapted depending on the door size ratio.

TH \ TB	300	350	400	450	500	550	600	650	700	750	800	850	900
2850	50	50	50	50	50	50	50	50	50	50	50	50	50
2800	50	50	50	50	50	50	50	50	50	50	50	50	50
2750	50	50	50	50	50	50	50	50	50	50	50	50	50
2700	50	50	50	50	50	50	50	50	50	50	50	50	49
2650	50	50	50	50	50	50	50	50	50	50	50	50	48
2600	50	50	50	50	50	50	50	50	50	50	50	49	48
2550	50	50	50	50	50	50	50	50	50	50	50	48	47
2500	50	50	50	50	50	50	50	50	50	50	49	48	46
2450	50	50	50	50	50	50	50	50	50	49	48	47	45
2400	50	50	50	50	50	50	50	50	50	48	48	46	45
2350	50	50	50	50	50	50	50	50	49	48	47	45	44
2301	50	50	50	50	50	50	50	49	48	47	46	45	43

Door weight in kg | TB = Door width in mm | TH = Door height in mm

**Accessories**

– Straightening fitting from page 236

**Planning/execution**

Configure with just a few clicks on [www.concepta.hawa.com](http://www.concepta.hawa.com)

Further information about the product can be found on [www.hawa.com](http://www.hawa.com).