

# GLIX DOOR WITH PIVOTING HINGES - CUTTABLE WIDTH

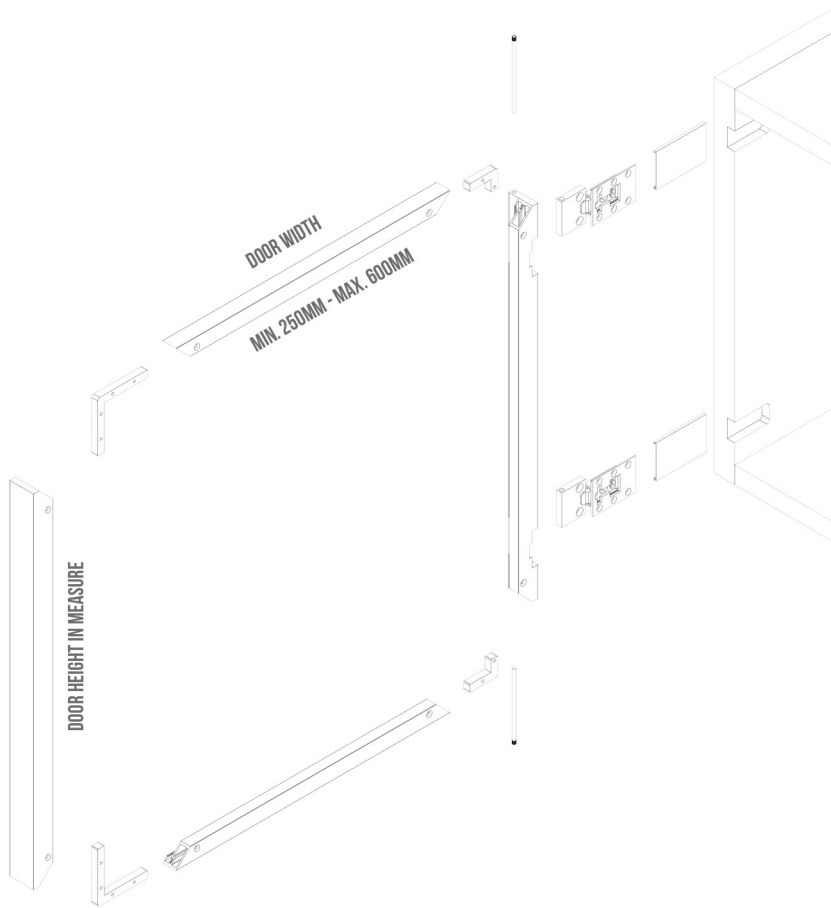

45° CUTTING REQUIRED FOR CONNECTING PROFILE



## DOOR KIT COMPOSITION:

- n° 1 Aluminium handle frame profile.
- n° 1 Aluminium frame profile milled for hinges.
- n° 2 Horizontal aluminium frames.
- n° 4 Connecting plates with screws.

## GLASS DIMENSION:

- Door Height minus 5mm
- Door Width minus 21mm
- Glass Thickness 4mm

## GLIX DOOR H 17MM (BETWEEN DOOR AND FLOOR)

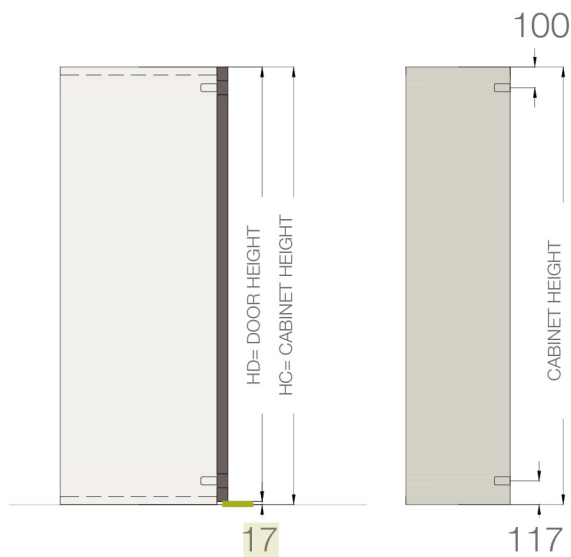

For calculate height of the door:  $HD = HC - 17 \text{ MM}$

## DOOR ADJUSTMENT

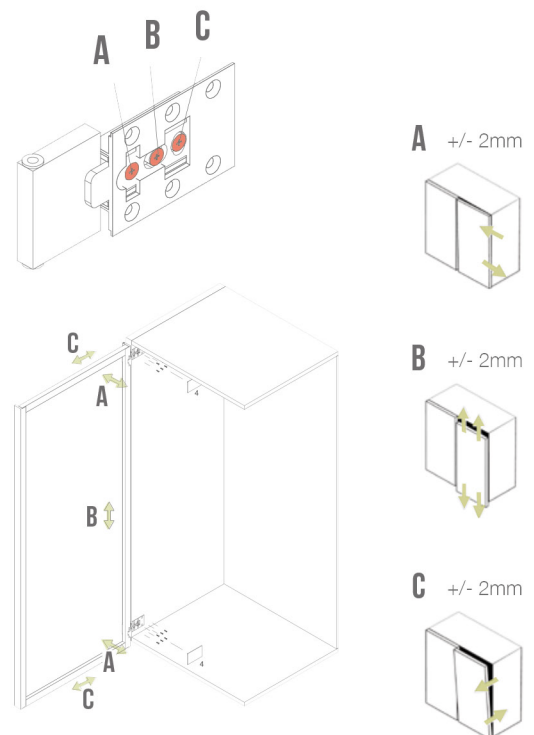

Attention:  
the regulation B must be adjusted in the same direction for both hinges.

## HINGED PROFILE

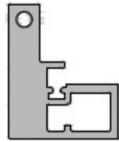
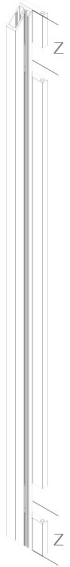

Length (mm)	Wardrobe Height (mm)	Z (mm)
2383	2400	100

**HP135.004.033** Rubber gaskets for glix profile in bars of 2,6mt

## HANDLE PROFILE

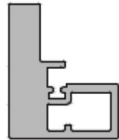
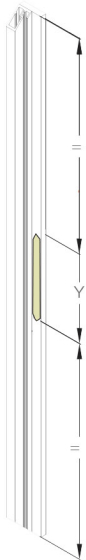

Length (mm)	Wardrobe Height (mm)	Y (mm)
2383	2400	400

Milling for Handle is always in the center of the profile.

**HP135.004.033** Rubber gaskets for glix profile in bars of 2,6mt

## HORIZONTAL CUTTABLE PROFILE



Length (mm)
3000

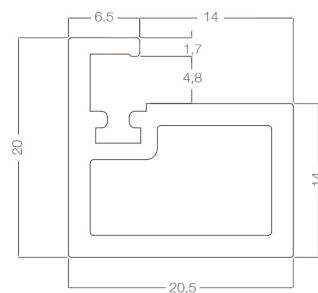

**HP135.004.033** Rubber gaskets for glix profile in bars of 2,6mt

# TECHNICAL ASSEMBLING INFORMATION

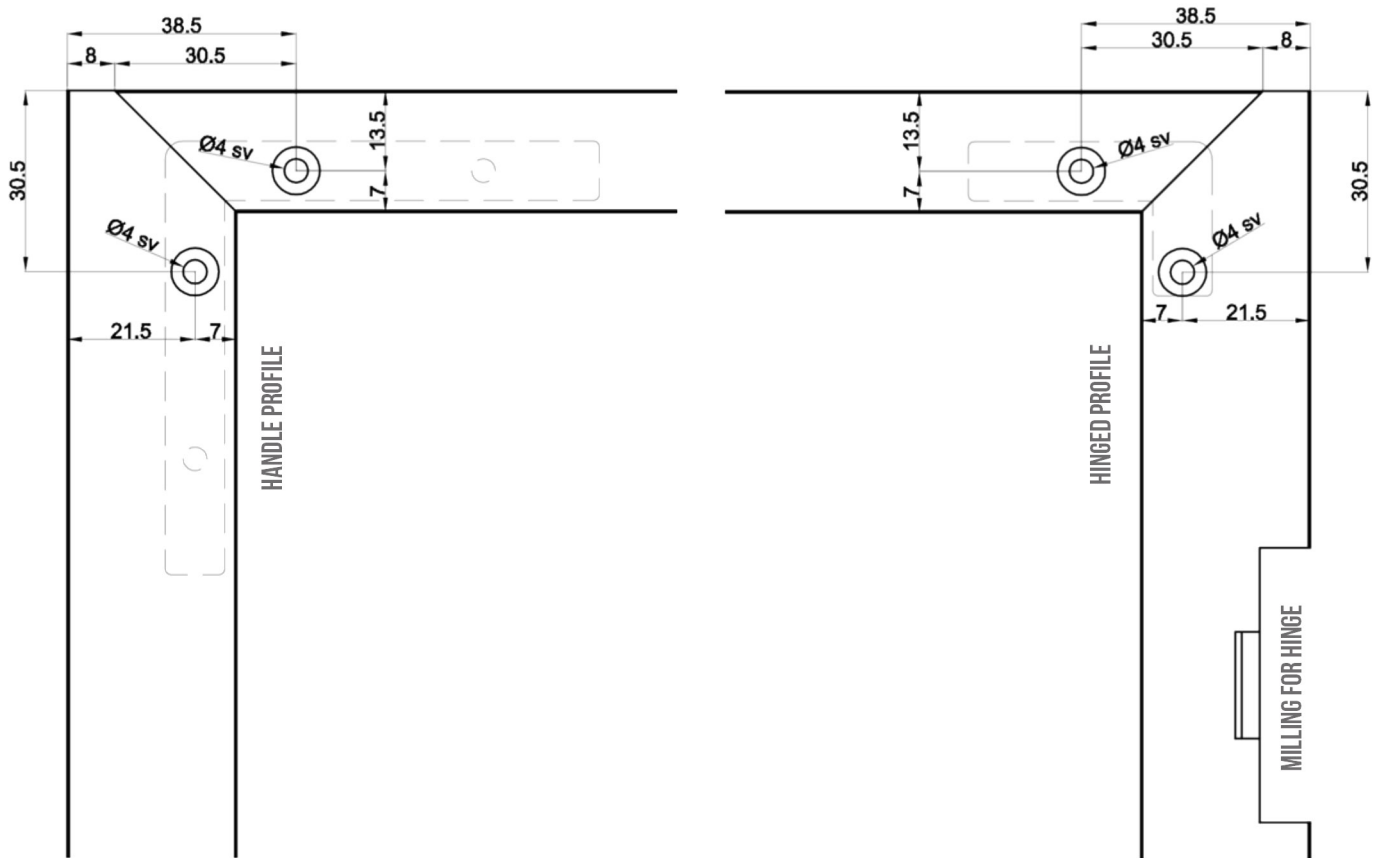

## KIT OF CONNECTING FITTINGS

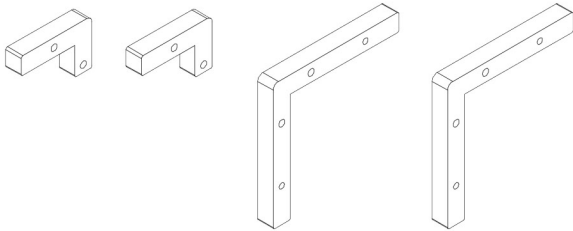

### Specification

Kit composed by  
 n°2 small connecting plates,  
 n°2 big connecting plates,  
 n°8 screws M4x10

## SET OF TWO SOFT CLOSE DEVICES:

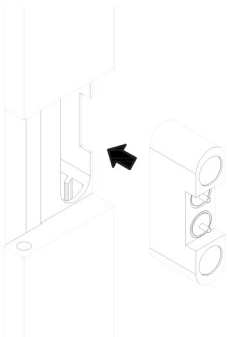

### Description

With damper and magnet

# SET OF TWO HINGES FOR VERTICAL PANEL THICKNESS 18MM

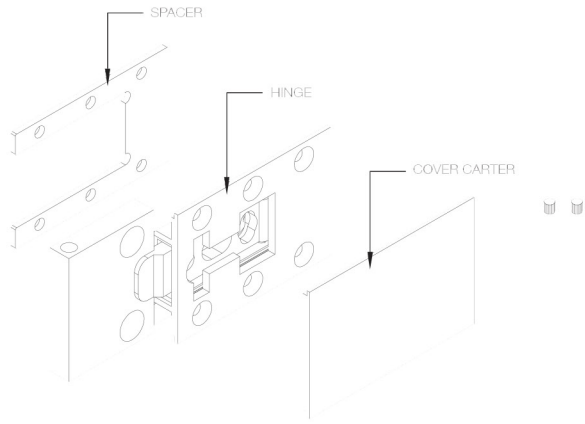

METAL PIN WITH THREAD

## MILLING REQUIRED

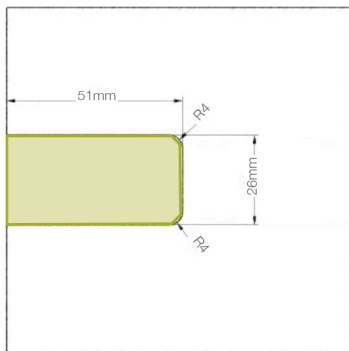

## SINGLE DOOR APPLICATION

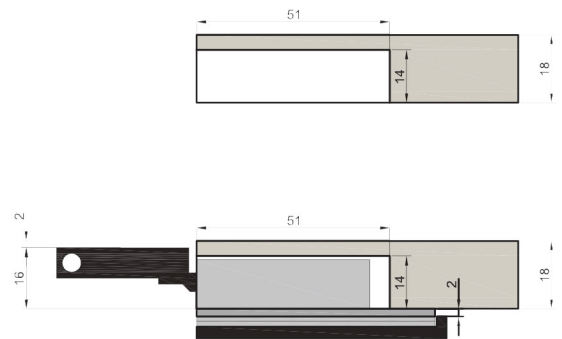
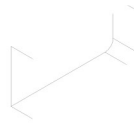

# SET OF TWO HINGES FOR VERTICAL PANEL THICKNESS 25MM

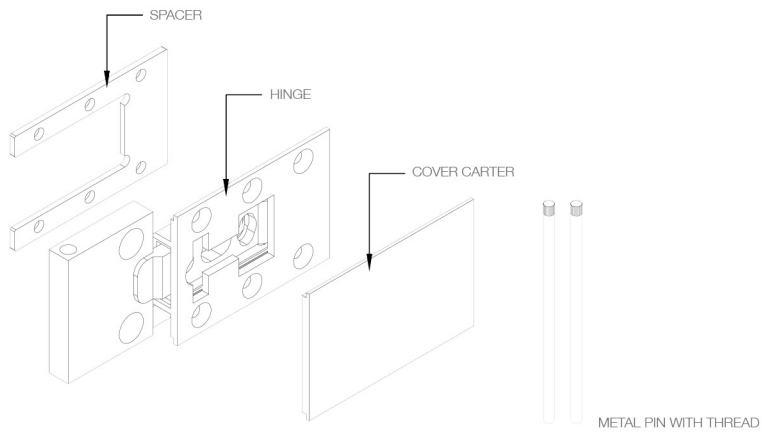

## MILLING REQUIRED

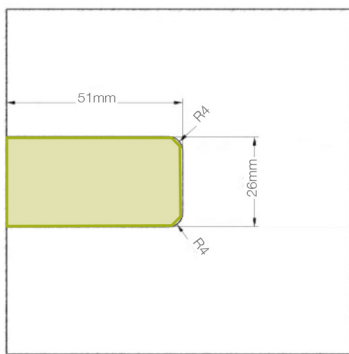

## SINGLE DOOR APPLICATION

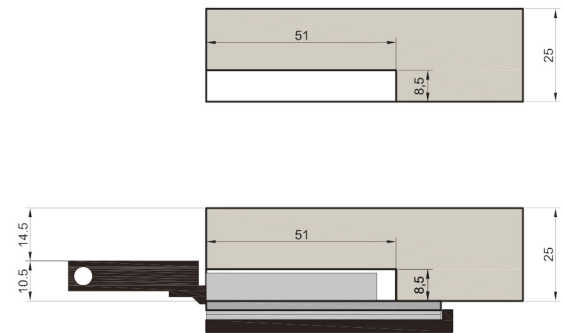

## DOUBLE DOORS APPLICATION

