

BRACKETS FOR SHOE RACKS

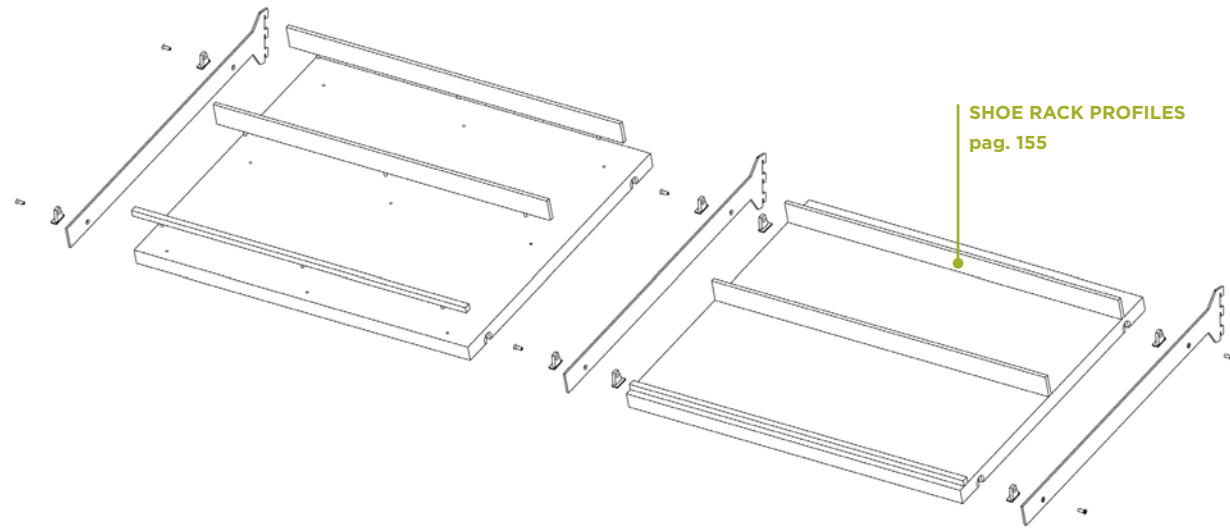

SHELF DEPTH 500(mm)

X	Y	Z
384	12.5	58

ITEM	FINISHING	SHELF DEPTH (mm)
CS001.010.007	Brown Metal Grey	500

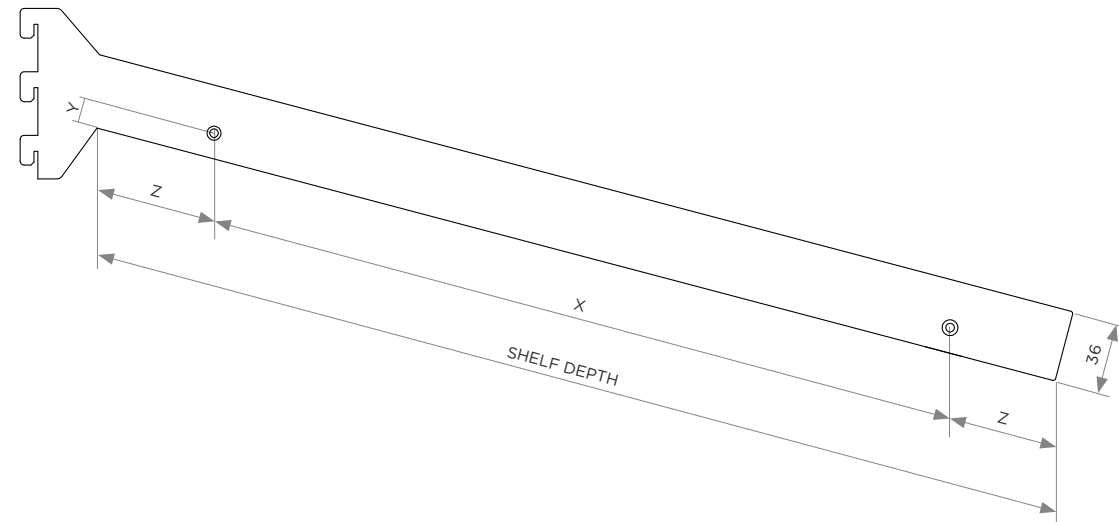

SHELF SUPPORTS FOR WOODEN SHELF - PANEL MINIMUM THICKNESS 25MM

EXTERNAL FIXING

ITEM	SPECIFICATIONS	BOX
CS001.012.001	Kit composed by 2 shelf supports with thread and 2 plastic nuts for wooden panel. M4x8 screws included	50



CENTRAL FIXING

ITEM	SPECIFICATIONS	BOX
CS001.012.002	Kit composed by 2 shelf supports with thread, 2 shelf supports with passing hole and 4 plastic nuts for wooden panel. M4x12 screws included	50

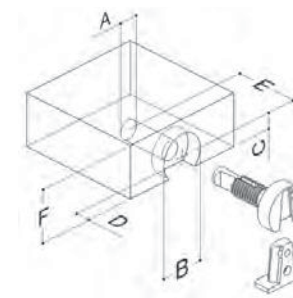
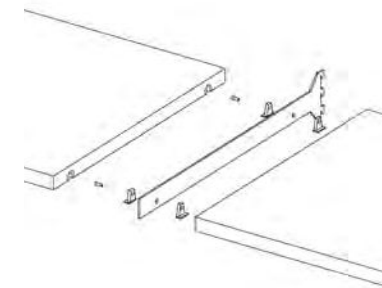
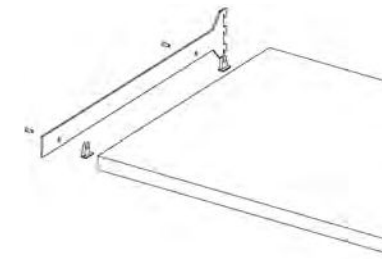

- A $\varnothing 9$
- B $\varnothing 21$
- C 7.5
- D 7
- E 31
- F 25

The use of our shelf supports is not mandatory.

SHELF SUPPORTS FOR WOODEN SHELF - PANEL MINIMUM THICKNESS 25MM

EXTERNAL FIXING

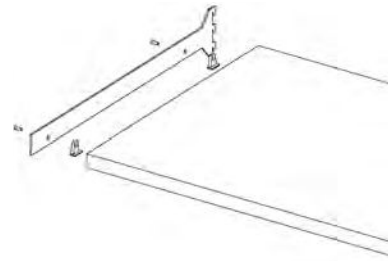

ITEM	SPECIFICATIONS	BOX
CS001.012.001	Kit composed by 2 shelf supports with thread and 2 plastic nuts for wooden panel. M4x8 screws included	50



CENTRAL FIXING

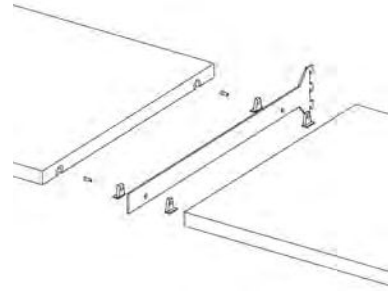

ITEM	SPECIFICATIONS	BOX
CS001.012.002	Kit composed by 2 shelf supports with thread, 2 shelf supports with passing hole and 4 plastic nuts for wooden panel. M4x12 screws included	50



a.

- A $\varnothing 9$
- B $\varnothing 21$
- C 7.5
- D 7
- E 31
- F 25

The use of our shelf supports is not mandatory.

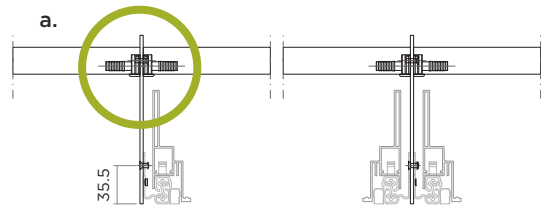

SHOE RACK PROFILES



SET OF ALUMINIUM SHOE RACK PROFILES

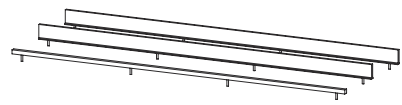

ITEM	SPECIFICATIONS	FINISHING	MEASURE (mm)	BOX
HP155.101.002	Module 900	Brown Metal Grey	880	
HP155.101.005	Module 600	Brown Metal Grey	580	

*other measures available on request.

